

SPRINGTEC LATERAL







Gama diseñada para la suspensión de falsos techos acústicos y maquinaria trabajando a partir de 450 r.p.m. Fabricado con muelle calidad cola de piano de gran resistencia mecánica, guiado por dos placas de caucho y con tope fin de carrera interior para evitar la posibilidad de contacto entre espiras, en caso de sobrecarga.

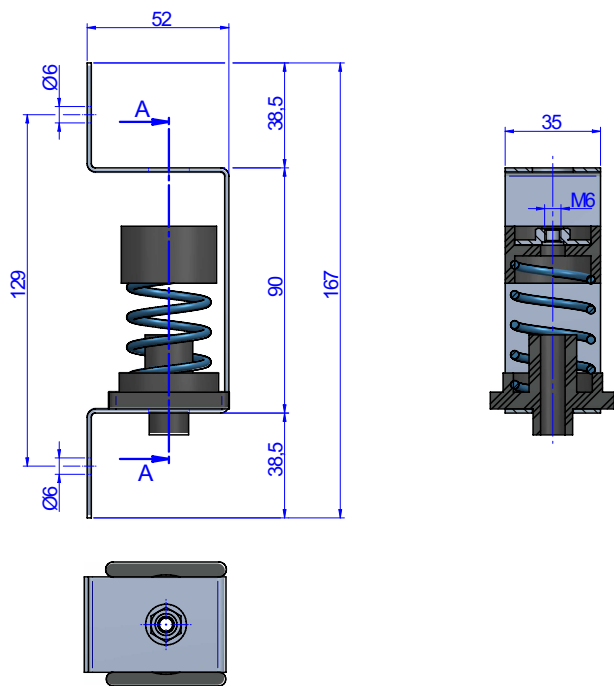

PLANOS



DIMENSIONES

	Tipo	Carga Max. Permanente (kg)	Color muelle	Peso (kg)	Código
	Springtec Lateral ST-5	5	Silver	0,151	23428
	Springtec Lateral ST-10	10	White	0,151	23406
	Springtec Lateral ST-20	20	Yellow	0,156	23407
	Springtec Lateral ST-30	30	Blue	0,156	23408
	Springtec Lateral ST-60	60	Magenta	0,156	23409

Propiedades elásticas

CURVAS DE CARGA FLECHA
AMC MECANOCAUCHO® SPRING TEC ST

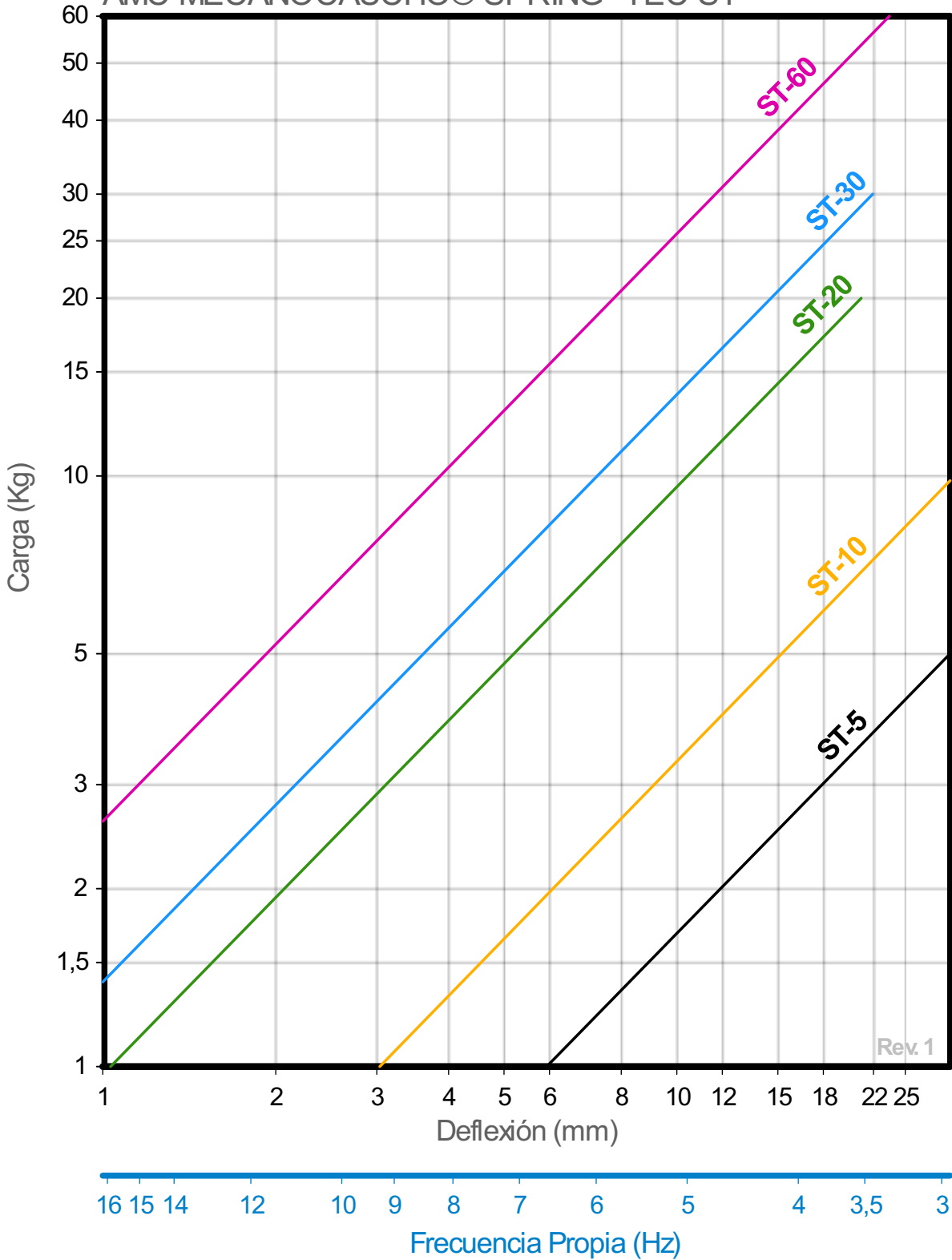

Rev. 1