

STANDARD HEIGHT ADJUSTERS



This height adjusting system is Zinc plated and chromate according to DIN 50691/ISO 2081 to protect against the corrosion.

TECHNICAL CHARACTERISTICS

DNV rules for ships/ High Speed light craft, Issue Jan 2016 Point 4 Chapter 3 Section1 F202, establishes that standard height adjusters are not acceptable for leveling, due to cyclic bending moments that the studs and bolts are subjected to. This is the reason why leveling of mounts using shims beneath the mounts is the only recommended method for leveling.

AMC-MECANOCAUCHO shares also this method and that is the reason why AMC-MECANOCAUCHO® Shims have been developed. In order to achieve a fine leveling HI-SEC height adjusters allow a final precise adjusting with security.

Standard height adjusters are not recommended by naval classification institutions neither by AMC-MECANOCAUCHO®. They are recommended only for static applications where leveling below 3mm is achieved.



DRAWINGS

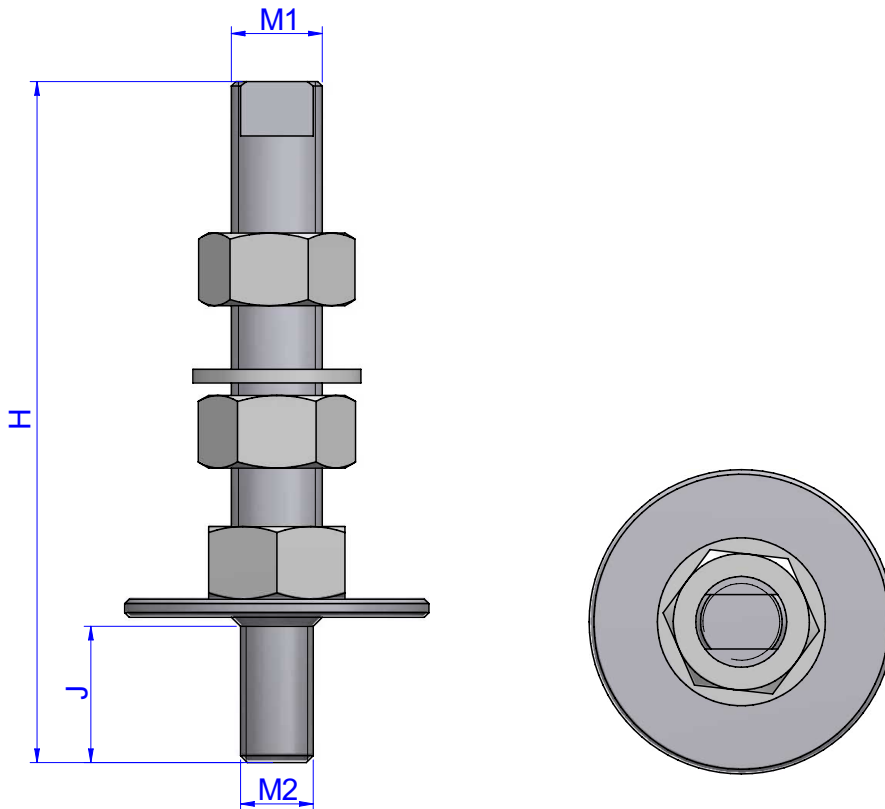

DIMENSIONS

Type	H (mm)	M1	M2	J (mm)	MACHINED HEAD	Weight (gr)	Code
STUD	100	M12	M12	-	Y	147	708001
	110	M16	M12	25	Y	0	708008
	110	M16	M16	-	Y	285	708003
	150	M20	M16	30	Y	475	708078
	130	M20	M20	-	N	475	708004
	135	M24	M24	-	N	1027	708049