

Anti vibration  
mounts

## EP 500 + SYLOMER®

**AMC**  
MECANOCAUCHO  
NOISE AND  
VIBRATION  
SOLUTIONS

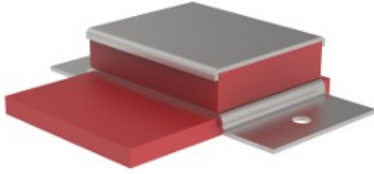

Acoustic wall ties range designed for the floating suspension of soundproofed walls. Sylomer® avoids the transmission of vibrations while providing optimal acoustic results. They have a "FAIL SAFE" rugged metal structure, which is overload-proof. Recommended for applications where fire or impact resistance is necessary. These mounts are also suitable for the isolation of vertical pipes, or any type of lightweight ducts that need to be isolated.



DRAWINGS

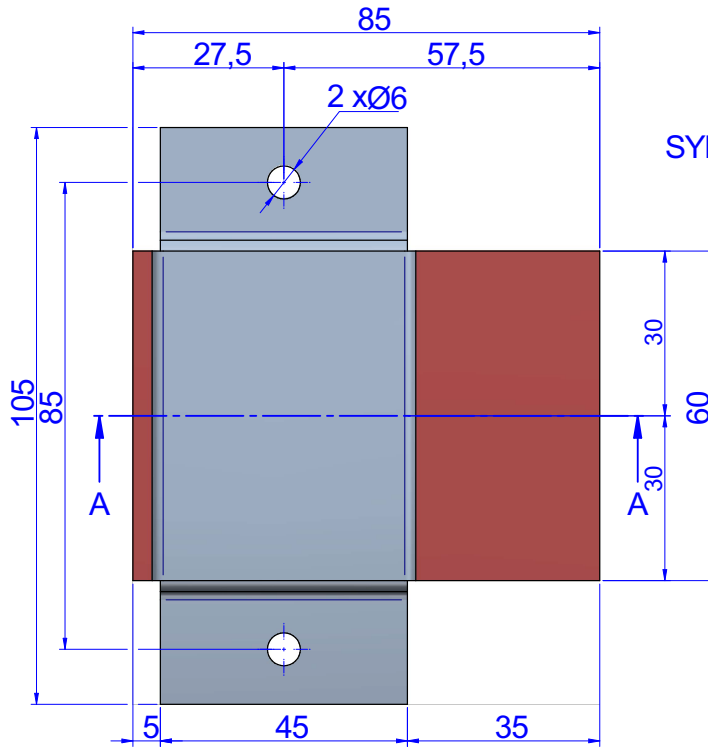
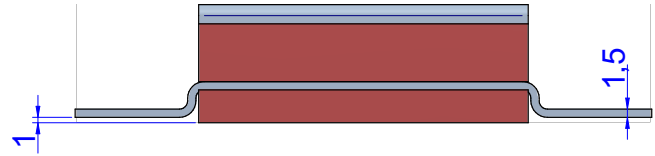
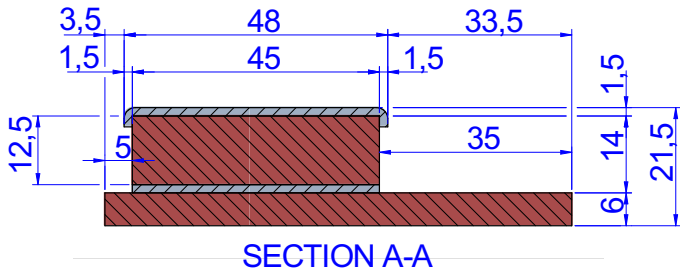

SYLOMER SR-220

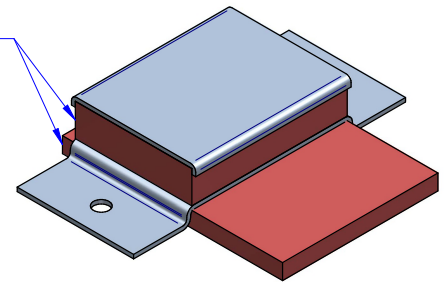

DIMENSIONS

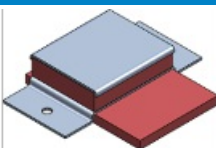
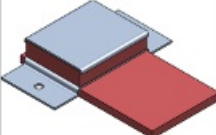
	Type	SUMMARY	LOAD kg MAX	Weight (kg)	Code
	EP 500 + Sylomer s35	They are secured by two "predrilled" and easy-to-cut pins to facilitate their installation.	60	0,141	23715
	EP 500 + Sylomer s65	They are secured by two "predrilled" and easy-to-cut pins to facilitate their installation.	60	0,147	23716

## Elastical properties

